

GM 1000 HPS

High Precision - for your astronomical future

10 MICRON
astro•technology

by COMEC-TECHNOLOGY



OFFICIAL EU-DISTRIBUTOR



www.10micron.de



GM 1000 HPS

This mount knows that it is a mount

The GM1000HPS mount is built for the demanding observer using photographic instruments up to a weight of 25kg – 55 lbs (counterweights not included).

The mount is driven by two AC servo motors with timing belt reduction and zero-backlash. Both axes feature a classic worm to wormwheel pairing. The wormwheels are

made of bronze (B14), have a diameter of 125mm and 250 teeth. 20mm alloy steel is used for the worms. The axes themselves are made of 30mm diameter alloy steel for maximum rigidity.

The double dovetail mounting plate offers maximum compatibility with instruments from other telescope manufacturers.



The connections of the control box.

The complete electronics is integrated into an easily removable, independent control box. All connectors of motors, encoders and hand pad are fixed with security lock screws.

The mount can be fully controlled with the included professional 4-lines standalone keypad, no external PC needed, not even for highly demanding jobs like satellite tracking.

The internally heated keypad is optimized for all light conditions – day and night – and for deep temperatures. It can be operated with gloves. Both the display and the ergonomic keys feature a red backlight.

The mount can be controlled with common software packages by connecting it to a PC with RS-232 serial port, Ethernet or WiFi, via the proprietary 10micron ASCOM driver or conventional compatible command protocols. Furthermore, a dedicated software (included) can be used to create a "virtual keypad", replicating exactly the functions of the physical keypad. The RS-232 port also allows the direct control of Baader Domes without PC.



4-Lines stand-alone Keypad with metal housing and heated screen – includes all functions for field use

This flexibility makes the GM1000 HPS an ideal mount for remote-controlled observatories. This mount knows that it is a mount.

The object database contains many star catalogs and deep-sky objects up to 16th magnitude. Solar system objects can be tracked with non-sidereal speed. Orbital elements of comets, asteroids and artificial satellites can be loaded into the mount, so that these objects can be tracked directly using the stand-alone keypad (without an external PC).

The usage of a model containing up to 100 stars makes the pointing accurate (visit www.10micron.de/downloads for the "Automated model maker for 10Micron GM mounts" by Per Frejvall). Modeling allows correction



of classical polar alignment and conic errors, and also of the most important flexure terms of the optical tube. This way it is possible to obtain pointing accuracies in the or-

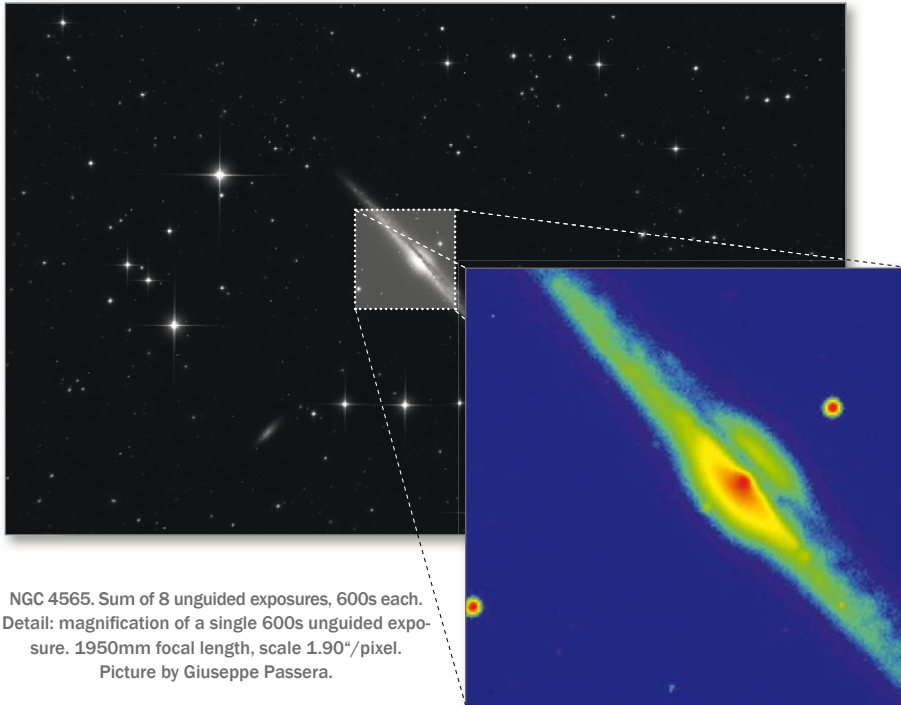

NGC 4565. Sum of 8 unguided exposures, 600s each. Detail: magnification of a single 600s unguided exposure. 1950mm focal length, scale 1.90"/pixel. Picture by Giuseppe Passera.

der of 20 arcseconds RMS. The same model can be used in order to obtain the maximum tracking accuracy, compensating also for the atmospheric refraction (depending on local atmospheric pressure and temperature).

A series of auxiliary functions provide automated align procedures for precisely aligning the mount to the celestial pole.

You may save and recover the alignment data of different observing sessions. This function is very useful if you have many instruments in different setups, each one requiring different flexure corrections (mount models).

Tracking through the meridian – a typical problem with german mounts – is solved by allowing tracking for up to 30° past the meridian (configurable) in both directions. In this way any object can be tracked for at least four hours.

The resulting tracking accuracy makes autoguiding unnecessary for most projects. The absolute encoders on both axes allow to obtain a typical tracking error below 1 arcsecond. However it is still possible to autoguide using the ST4-compatible port or through the serial/Ethernet connection, with a guide rate configurable from 0.1x to 1x. The guide rate can be automatically corrected for the target declination, there is no need of recalibrating the autoguiding parameters when observing at different declination.



Tripod connection with standard base adapter flange # 1451092 (included)

10micron GM 1000 HPS on ARIES tripod #1451055

Designed for field use, the GM1000HPS is easily transportable. The main body of the mount without the counterweight shaft has a weight of only 19.5 kg – 43 lbs.

All functions of the mount are targeted to obtain maximum flexibility for actual field conditions.

The mount can be switched on and off using the dedicated connector on the control box panel and it can be parked in different user-defined positions.

You can use the electronic balance functions in order to balance your instrument without unlocking the clutches.

A Baader-dome can be controlled without an external PC or Laptop via RS-232 serial port. Once configured with your instrument parameters, the firmware is able to make all the calculations required for positioning the dome slit in front of your optical tube for almost all instrument configurations

GM 1000 HPS SCOPE OF DELIVERY

- embedded Computer Controller with Linux Management System for complete remote use of the mount incl. all functions such as satellite tracking, lunar tracking speed and more
- Interface: RS232, Ethernet, Wi-Fi
- Connectors for: GPS, Autoguider, Keypad, Mount, Aux and Remote Switch
- Latest QCI software (Version 2.x)
- Connection cables, counterweight bar
- PC Software: Virtual Keypad, Clock Sync Tool, Multi Mount modelling, ASCOM Driver
- Instruction manual
- #1452059: 4-Lines Stand-Alone Keypad with metal housing and heated screen
- #1451090: Tripod-Pillar Adapter
- #1451092: Standard base adapter flange
- #1451065: Mounting-head protective Cover (Cordura)
- #1451066: High-density foam fitted transport cardboard box

Mount dimensions (mm) at latitude 45°

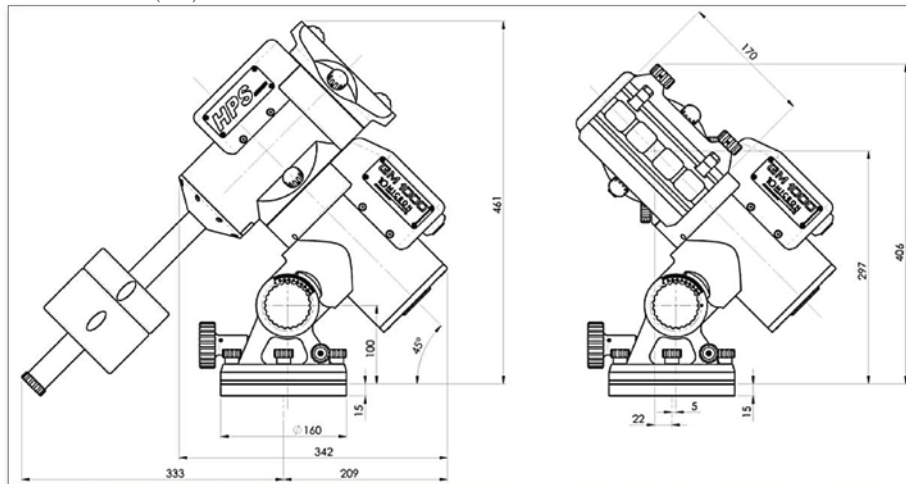

THE HPS TECHNOLOGY

*HPS stands for **High Precision and Speed**, representing the essence of the latest 10micron mounts. High precision, thanks to an innovative and exclusive absolute encoder paired with 10micron manufacturing. High speed, thanks to high performance electronics and AC servo motors*

The HPS-series mounts are equipped with a pair of ultra-high resolution absolute encoders, directly mounted at the right ascension and declination axis.

This technology has already been used in professional observatories, where high costs and complexity is not an issue. Measuring the rotation angles of the axes directly allows to compensate for most of the mechanical errors, such as periodic errors and transmission backlash. However, this requires systems with very high resolution.

In the past few years this technology could also be found in amateur astronomers' instruments, often paired with the use of direct drive technology where motors are mounted directly on the mount's axes – without any mechanical reduction gear.

10Micron GM mounts continue to feature the traditional worm to wormwheel drive solution, while pairing it with state of the art encoder technology. The encoders do their job with 1/10 arcsecond resolution. This enables GM mounts to perform at the same level of precision as professional direct-drive mounts (without any mechanical drive) but without all the downsides of a mount only controlled by electronically manipulating magnetic fields.

10micron mounts need no homing and are much less prone to motor stall and adverse balancing conditions or heavy windload/gusts than direct-drive mounts.

For your remote observatory a GM-mount is a workhorse – not a prima donna.

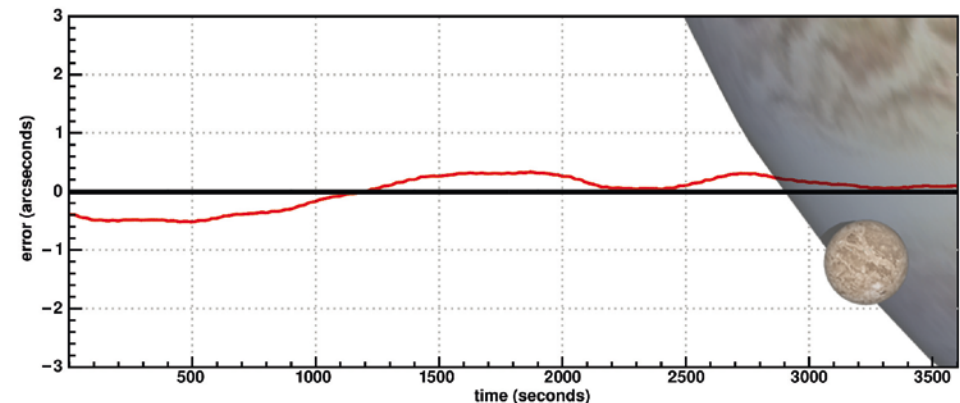

Tracking error profile measured with an encoder coupled to the r.a. axis. Jupiter and Ganymede are shown as they appear from Earth, at the same scale.

GM 1000 HPS

MAIN ACCESSORIES



Power converter 12V/24V 5Ah
converts 12 V input into 24 V 5 A output, for field use. ONLY use with 12 V battery.
#2457577A

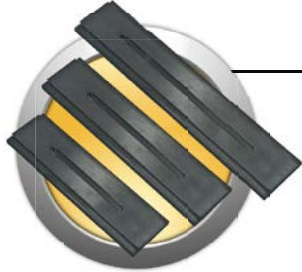

3" dovetail bar w/o holes
Losmandy-style, Length: 300 / 400 / 500mm
#1452125 / #1452130 / #1452131

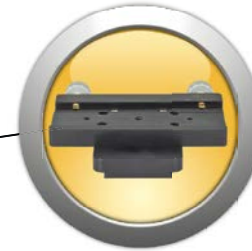

90° Changeplate for 3" LODUAL
dovetail Adapter required to mount the LODUAL double mounting plate on the GM1000 mount.
#1451045



3" LODUAL double mounting plate
balancing design, Losmandy-style, for mounting of two telescopes. Center-to-center distance 27 cm.
#1452105

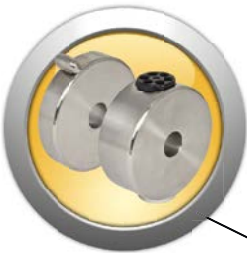

Counterweights 3kg / 6kg
stainless steel
#1452072 / #1452073



Stabilized power supply AC
converts 230 V input into 24V.
#1451070

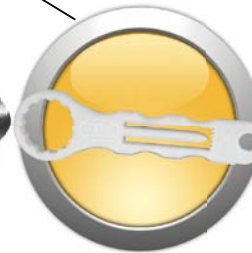

Baader RA/DEC torque wrench
allows easy operation of GM 1000 HPS axis knobs without indicating too much force
#2450070



"Economy" T-Pod, Aluminium
Heavy duty Baader aluminum tripod 75-110cm, black anodized, carrying bag, 6.9kg weight
#2451010



Heavy steel pillar + flange
conical shape, with inner labeling tubes. 80/100/115/125/134/145/155/165 cm
#2451210 + #2451187



Tripod/Pillar Adapter Flange
Included with GM 1000 HPS
Black anodized aluminum, incl. screws
#1451090

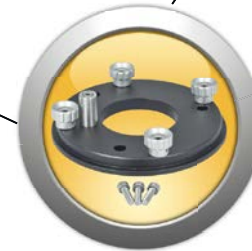

Standard base adapter flange
Included with GM 1000 HPS
incl. knobs, screws and azimuth block for tripods/pillars
#1451092



ARIES Tripod, Aluminium
including accessory tray and waterproof cordura carrying bag, 75 - 115cm, 80kg payload, weight: 13kg
#1451055



Missing something?

More accessories on next page and www.10micron.de

ADDITIONAL ACCESSORIES

Everything you need for your GM 1000 HPS mount



#1451063
Prof. Flight-Case (2 pcs)
Head- and Counterweight-Flight-Case set (trolley + hand case). With internal padding and aluminum reinforced corners/edges



#1451062
TTX01 Hardcase-Set (2 pcs)
Two trolley cases for total protection against water, dust, chemicals, impact & drop. With internal padding



#1451067
Carrying bag
Reinforced cordura carrying bag with handles. Designed to recycle the shaped padding included with the standard pack



#1451066 *Included with GM 1000 HPS*
Special foam fitted transport cardboard box
Shaped inner padding and sturdy cardboard box with handles



#1451065 *Included with GM 1000 HPS*
Mount protective cover
Cordura cover with upper zip, can be placed on the mount even with payload attached



#1482010
StickStation (USB-Weatherstation)
delivers high precision data of barometric pressure, temperature, relative humidity and dew-point



#1455005 *Included with GM 1000 HPS*
WiFi Upgrade board
Wi-Fi connection with access point and routing function. Included with HPS mounts from 11/15



#1454105
GPS receiver module
Directly connected to the mount, provides the exact time and coordinates of the observation site.



#1452059 *Included with GM 1000 HPS*
Professional 4-Lines Keypad
from aluminium with heated screen to equip any old mount with firmware 2.x and higher. Stand-Alone!

GM 1000 HPS UPGRADE-PACKAGES

The perfect addition to complete your GM 1000 HPS mount



#1451025

Upgrade-Package "Economy" for GM 1000 HPS

- #1452072 / #1452073 | 2pc counterweight set of 3kg and 6kg - stainless steel with 30mm diameter
- #2451010 | **Baader Aluminium T-Pod** 110mm, complete with upholstered Cordura transport-bag
- #1451062 | TTX01 Travelcase-set (1 Trolleycase for GM 1000 HPS mount /1 hard case for counter weights), total protection against water, dust, chemicals, impact & drop
- #1451070 | Power-Supply outdoor type 230V / 24V- 4A - 90W
- #1455010 | PERSEUS Software Package. Astronomy simulation software and mount control via PC

Please note: Mount is not included in the Upgrade Package

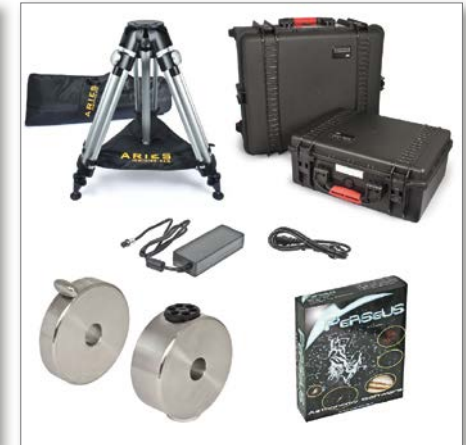

#1451026

Upgrade-Package "Professional" for GM 1000 HPS

- #1452072 / #1452073 | 2pc counterweight set of 3kg and 6kg - stainless steel with 30mm diameter
- #1451055 | **ARIES tripod**, including accessory tray and waterproof cordura carrying bag
- #1451062 | TTX01 Travelcase-set (1 Trolleycase for GM 1000 HPS mount /1 hard case for counter weights), total protection against water, dust, chemicals, impact & drop
- #1451070 | Power-Supply outdoor type 230V / 24V- 4A - 90W
- #1455010 | PERSEUS Software Package. Astronomy simulation software and mount control via PC

Please note: Mount is not included in the Upgrade Package



Attention: ALL 10 MICRON mounts should ONLY be used with approved power supplies from this brochure or our price list. Damages induced by using third party power supplies may result in loss of warranty! For more Information visit www.10micron.de/warranty

PUSHING THE PERFORMANCE ENVELOPE

The effort to improve performances never stops

The most important features defining the performance of an astronomical mount are the **tracking accuracy** and **maximum slew speed**. Constant technological evolution allows to continuously improve these numbers. From the first GM2000 FS2 mounts with stepper motors to the new GM3000 HPS, tracking accuracy has been improved by an order of magnitude and the pointing speed has been improved by a factor of three.

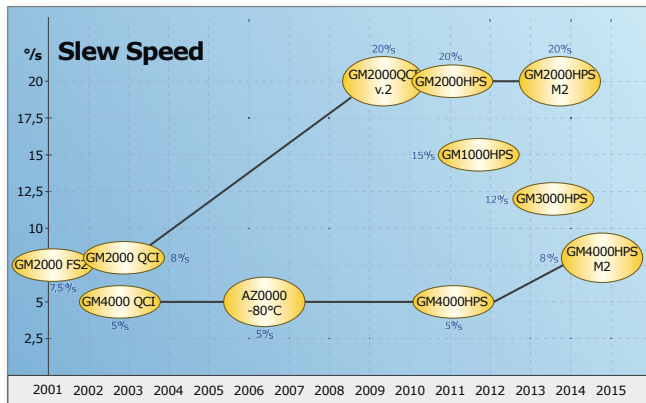

High slew speed is required for many astronomical applications. Searching for supernovae, asteroids or exoplanets, where images from a large number of different objects are required in minimum time, as well as tracking artificial satellites.

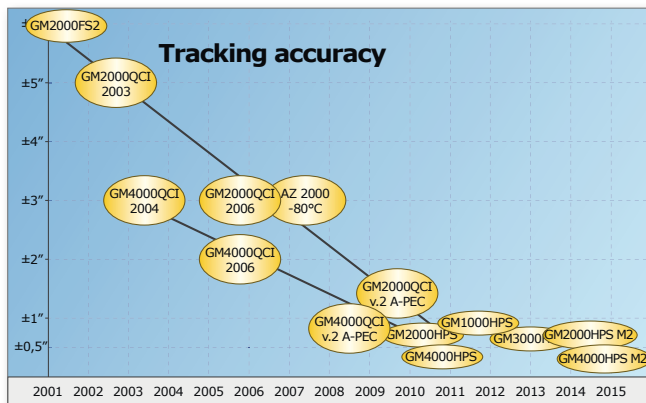

On the other hand an excellent tracking accuracy is required for high-resolution deep-sky imaging, in order to simplify or completely get rid of complex autoguiding systems, which can be a killing source of errors or breakdowns for remote controlled observatories.

FIFTEEN YEARS OF HISTORY

More than fifteen years of experience in astronomical manufacturing

The 10micron mount line was born in 2000 with the clear aim of providing products with high quality standard: equatorial mounts, altazimuth mounts and tripods – always designed for best performance.

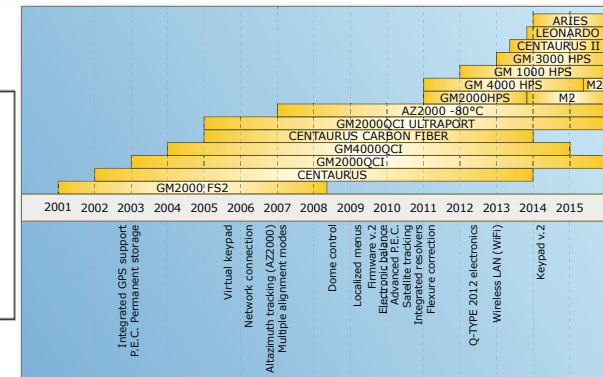

The 10micron product range

The complete range of traditional german equatorial mounts from GM 1000/2000/3000/4000 HPS, up to the special application AZ2000 altazimuth mount, the 10micron product range is dedicated to serve the most demanding imagers and university level observatories as well.

10 MICRON HPS MOUNTS

Unguided imaging, satellite tracking, high-precision spectroscopy and much more



M-13 : © Markus Beer
GM 1000 HPS and TEC 140;
Canon 5D Mark II, exposure
10x7min., 400 ISO.
UNGUIDED!



„Quality exists - when the price is long forgotten“ Sir Henry Royce - founder of RollsRoyce

The new generation of 10Micron HPS mounts is only available in UV-stabilized hardened black anodizing. This surface looks as if it were a structured paint. But it is long-lasting and much more scratchproof than ordinary black paint, while it shows a deep and lustrous black that will stay impermeable to aging.

DRIVE MECHANICS

- Self-locking, high-precision worm-wheel-drives with classic friction clutches
- Internal wiring – no external mount cables
- High torque Servo DC motors eliminate imbalance motor stall
- Proprietary motor-electronics for easy servicing

DRIVE ELECTRONICS

- Absolute on-axis encoders in RA & Dec, featuring more than 10 million increments (interpolated), fully encapsulated and calibrated
- Up to 0.6" RMS tracking accuracy – for long duration unguided imaging
- Closed loop (encoder controlled) satellite tracking speed – up to 20°/s (GM 2000)
- Extremely low power consumption and miniature format (20 x 15 x 8cm) electronics
- After an observing session, the entire electronics box (motor electronics with Linux computer) and HC can be easily detached and protected from premature aging and moisture damage – Virtual Keypad on PC available for remote control
- Service friendly design – electronics box and HC can be easily exchanged for service, without returning the precisely adjusted HPS mount

FIRMWARE

- Dual Tracking, automatic refraction (configurable) and flexures correction functions implemented – the only way for perfect unguided tracking during long exposures
- Intuitively operated V.2 software, proprietary motor control system with temperature compensated clock and integrated into an onboard Linux computer – intelligence built-in
- No external PC or laptop mandatory in the field – all functions in the onboard computer can be accessed via stand-alone hand control unit (HC)
- Precise multistar pointing models, entering satellite and comet trajectories, programming individual observing sessions and much more
- Well documented firmware and drivers, working autonomously w/o additional planetarium software, without need for external RS-232 converters / USB ports
- Excellent documentation in English and German
- Electronic balance – requiring one time balancing only
- Ultra stable pointing models for safe East/West load reversal – no change of pointing model necessary when changing accessories. Recordable models database for different telescope setups
- Precise polar alignment – software aided and accomplished within minutes
- Fully remote controlled via your observatory PC with 10/100/1000LAN and WiFi option included – perfectly prepared for your future Internet observatory
- Manual, automatic (Clock Sync proprietary software) or GPS based time; leap seconds support for the different timescales of UT1 and UTC
- Remote diagnostics web assist option w. dedicated server

TECHNICAL DATA



SPECIFICATIONS	GM 1000 HPS	GM 2000 HPS III	GM 3000 HPS	GM 4000 HPS III
Mount Type	German Equatorial Mount			
Weight (mount w/o acc.)	~ 19.5 kg – 43 lbs	~ 33 kg – 73 lbs	~ 65 kg – 143 lbs	~ 125 kg – 276 lbs
Weight, Ultraportable version (mount)	-----	~ 18,5 kg – 40 lbs + ~ 15 kg – 33 lbs (without accessories)	-----	-----
Instrument payload capacity	25 kg – 55 lbs	50 kg – 110 lbs	100 kg – 220 lbs	150 kg – 330 lbs
Latitude range	0° – 82° (90° optional)	20° – 70°	20° – 70°	20° – 70°
Azimuth fine adjustment range	+/- 7.5°	+/- 10°	+/- 10°	+/- 10°
Counterweight shaft	30 mm diameter, stainless steel, weight 1.7 kg – 3.7 lbs	40 mm diameter, stainless steel, weight 4 kg – 9 lbs	50 mm diameter, stainless steel, weight 8 kg – 18 lbs	60 mm diameter, stainless steel, weight 13 kg – 29 lbs
Axes	30 mm diameter, alloy steel	50 mm diameter, alloy steel	a.r. 80mm / dec. 50mm diameter, alloy steel	a.r. 85mm / dec. 80mm diameter, alloy steel
Bearings	Pre-loaded tapered roller bearings	Pre-loaded tapered roller bearing	Pre-loaded tapered roller bearing	Pre-loaded tapered roller bearing
Worm wheels	250 teeth, 125 mm diameter, B14 bronze	215 teeth, 172 mm diameter, B14 bronze	a.r. 315 teeth, 244 mm diameter, B14 bronze dec. 250 teeth, 192 mm diameter, B14 bronze	a.r. 430 teeth, 330 mm diameter, B14 bronze dec. 315 teeth, 244 mm diameter, B14 bronze
Worms	20mm diameter, tempered alloy steel, grinded and lapped	24mm diameter, tempered alloy steel, grinded and lapped	32mm / 24mm diameter, tempered alloy steel, grinded and lapped	32mm diameter, tempered alloy steel, grinded and lapped
Motors	2 axes AC servo brushless			
Power supply	24 V DC			
Power consumption	~ 0,5 A while tracking ~ 3 A at maximum speed ~ 4 A peak	~ 0,7 A while tracking ~ 3 A at maximum speed ~ 5 A peak	~ 1 A while tracking ~ 3 A at maximum speed ~ 5 A peak	~ 1.5 A while tracking ~ 5 A at maximum speed ~ 6 A peak
Go-to speed	Adjustable from 2°/s to 15°/s	Adjustable from 2°/s to 20°/s	Adjustable from 2°/s to 12°/s	Adjustable from 2°/s to 8°/s

GENERAL SPECIFICATIONS

Transmission system	Backlash-free system with timing belt and automatic backlash recovery
Pointing accuracy	< 20" with internal 25-stars software mapping - max.100stars; possibility to use the Model Maker software for automated alignment operation.
Average tracking accuracy	~ 1" typical for 15 minutes ~ 0,6" RMS with internal 25-stars software mapping and compensation of system flexures and polar alignment errors
Security stop	+/- 30° past meridian in r.a. (software) +/- 45° past meridian in r.a. (mechanical)
Communication ports	RS-232 port; GPS port; autoguide ST-4 standard port; Ethernet 10/100/1000 port
Database	Stars: by Common Names, Bayer designation, Flamsteed designation, Bright Star Catalogue, SAO, HIP, HD, PPM, ADS, GCVS. Deep-sky: M, NGC, IC, PGC, UGC limited up to mV = 16. Solar system: Sun, Moon, planets, asteroids, comets, artificial satellites. Equatorial and altazimuth coordinates. User defined objects. Quick slewing positions recalls for frequent focusing or useful operation.
Firmware features	User defined mount parking positions, 2stars and 3stars alignment function, up to 100 alignment stars for modeling, correction of polar alignment and orthogonality errors, estimate of average pointing error, storage of multiple pointing models, sidereal, solar and lunar tracking speed adjustable on both axes, declination-based autoguide speed correction, adjustable horizon height limit, pointing and tracking past meridian, assisted electronic balance adjustment, automatic (ClockSync proprietary software) manual or GPS time & site coordinates synchronization, leap seconds support and full accounting for the UT1-UTC timescale, configurable atmospheric refraction, direct Baader dome control via RS-232, network settings, comets and asteroids filter, multi-language interface. Remote Assist via Internet connection with dedicated server.
Keypad control	Rugged keypad with metal housing and reliable professional micro switches, Large graphic display – heated for operation under lowest temperatures, dimmable display and keyboard with back-lit keys, five information menu lines for coordinates, object information and symbols showing mount status and active external connections and accessories. All the functionality of the mount is available through the keypad without requiring an external PC
PC control	Remote control via RS-232, Ethernet, proprietary 10Micron ASCOM driver, LX200 compatible protocol, update of firmware and orbital elements of comets, asteroids and artificial satellites via RS-232 or Ethernet, PC virtual Keypad control panel via RS-232 or Ethernet, Integrated Wi-Fi for connection with smartphones and tablets and any wireless network

We reserve the right for errors and manufacturers modification

10MICRON: NO COMPROMISES

The development of 10micron products is aimed to provide best performance and maximum ease of use

The availability of more and more advanced and flexible astronomical imaging systems opens new ways to work on the sky: today, ultra-high definition and ultra-high speed imaging is within the amateur's reach, way more as predicted ten years ago. 10micron's products evolved at the same pace, in terms of tracking, pointing accuracy and speed. The HPS-series mounts are at the peak of this process.

Every observer knows that when you are under the sky you have little time and each set up operation comes with the risk of compromising the night. Having excellent performance on paper means nothing if you need too many complex set up operations.

This is the reason why 10micron mounts are designed for the user's needs, and not to enforce the mount's way of operation onto the user.

10micron mounts are now used in open field as well as in remotized sites, in educational observatories as well as in the extreme climates of northern Canada and the Atacama desert.



GM 1000 HPS

GM 2000 HPS II



GM 3000 HPS

GM 4000 HPS II



AZ 2000 mount in NyAlesund at 80° North latitude



www.10MICRON.DE



Authorized 10Micron Dealer

