



Educational Microscope ECLIPSE Ei

ECLIPSE Ei

Educational Microscope



Shedding New Light
On **MICROSCOPY**

Look into the future

Curiosity – the genuine desire to study the world and unlock its mysteries – is the starting point of science and technology. The ECLIPSE Ei educational microscope offers unique digital and design solutions to ensure the smooth progress of your courses. Using the ECLIPSE Ei to foster your students' curiosity and maintain their enthusiasm for learning, you can unlock their potential and open their eyes to the world around them.



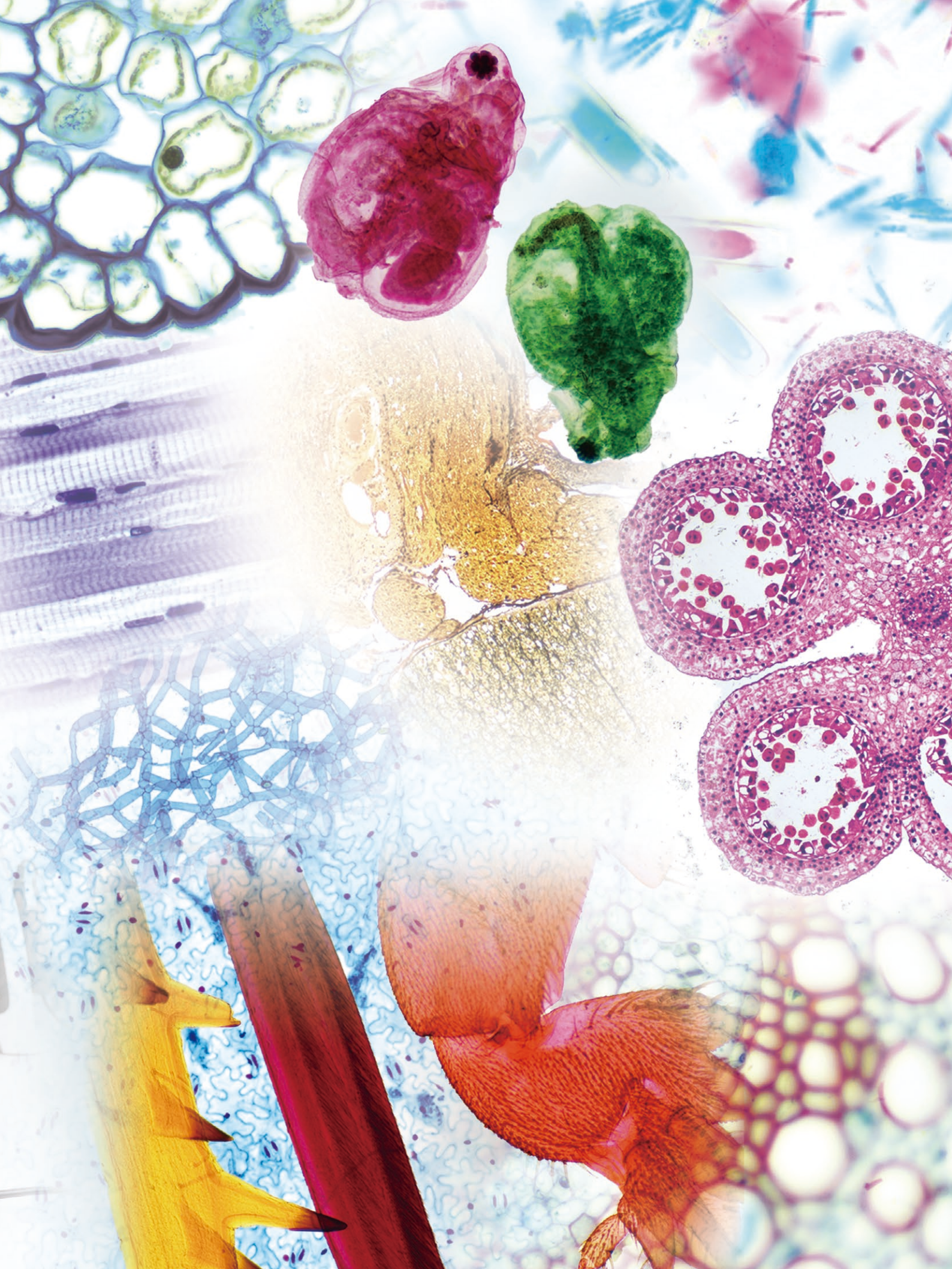

New generation digital solutions that stimulate curiosity

Students can enjoy learning how to operate the ECLIPSE Ei using its smartphone-friendly Online Guide. Digital cameras that enable sharing of discoveries and experiences through images are also available to stimulate your students' intellectual curiosity.



Teach yourself microscope operation with the Online Guide

By simply scanning a QR code, students can quickly access the Online Guide on their smartphones to independently learn how to operate the microscope. The Online Guide can also be useful in preparing students before using the microscope and to reinforce concepts after using the microscope.

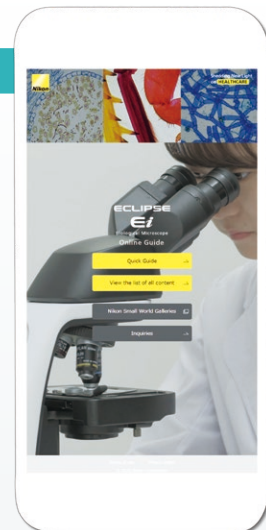

You can select the Quick Guide, which offers video lectures on basic operations, as well as a Contents List that introduces details about operations and the cleaning procedure.

Sharing Discoveries and Experiences of the Microscopic World

The Digital Sight 1000 optional microscope camera is simple to operate and ideal for use with the ECLIPSE Ei. Not only can users record images and videos of specimens, but they can also simultaneously observe images with others via a monitor or network.

For group observations

By using a monitor to display an image under observation with the ECLIPSE Ei, a group of people can observe the same specimen simultaneously.



For lectures and seminars

The Digital Sight 1000 camera can be easily connected to a large display for classroom lectures and seminars.



Perfect for online education

By connecting the Digital Sight 1000 camera to a tablet PC equipped with NIS-Elements L imaging software, images of specimens on the ECLIPSE Ei can be easily shared in real time with other PCs and smart devices. This system is a powerful tool for virtual teaching using web conferencing services.



Images under observation with a microscope can be shared in real time, with students even in distant locations. (The above diagram illustrates an example using the web conferencing service.)

Intuitive design that expands learning possibilities

Both ease of understanding and operability, which respectively enable intuitive and stress-free operation, are in demand. Our unique design expertise has been applied to every aspect of the microscope. The accompanying Online Guide empowers students to learn how to operate the microscope independently, revolutionizing the conventional class workflow and saving time for practical training.



Simple, Intuitive Interface

The body of the ECLIPSE Ei is designed to provide smooth and seamless operation which facilitates quick observation. Simple and intuitive markings on the ECLIPSE Ei, from illustrations to color-coding, enable students to quickly understand how to operate the various aspects of the microscope.



1 Lighting status can be checked at a glance

The power switch and light intensity control knob are all located at the front.



2 Reversed-type nosepiece

You can check which objective is in use and change magnifications without other objectives getting in the way.



3 Illustrative presentation of handles

The handles for moving the stage in the X/Y direction are displayed using illustrations of their respective shapes.



4 Stress-free stage operation

The simple stage shape has no bothersome projections on either side.



5 Fine focus with either hand

The coarse/fine focus knobs for moving the stage up and down are positioned on both sides of the microscope.



6 The best aperture can be set intuitively

The lever positions of the condenser aperture are color-coded and matching the objectives.



7 Safe and secure focusing

Stage height limits can be set to prevent specimen and objective collision and damage.



8 Tube orientation displayed during storage

The tube can be rotated to reduce the space required for storage by loosening the tube locking screw. The tube is designed so that it does not fall.

30% lighter for stress-free setup*

*Compared to previous halogen lamp models

The ECLIPSE Ei features a compact, light-weight body that saves space and is easy to handle, as well as a robust design that is built to last. It is easy to carry and store, reducing the stress of setting it up and storing it.



Compact, space-saving design

The compact footprint saves valuable space at the bench or desk. In addition, the tube can be rotated towards the back to minimize storage space.



Superior portability and weight

Its dramatically reduced weight and multiple grip locations make the ECLIPSE Ei easy and stable to lift, carry and store, even on high shelves.



Integrated cord winding system

The AC adaptor can be stored at the back of the microscope. The power cord can also be wound up when storing.



Loss prevention

A security wire slot is provided and supports maintenance.

Nikon's optical technology captures specimen details with stunning clarity and true colors

Nikon has been developing and refining optical technology since its founding in 1917. The ECLIPSE Ei features Nikon's high quality optics resulting from over 100 years of optical expertise.



High definition, large FOV optical system

The dedicated CFI BE2 Plan Achromat series objective and the 10X eyepiece achieve a large field of view of 20*, enabling students to find their target specimen or structure more quickly. Infinity-corrected objectives with excellent image flatness and chromatic aberration correction provide high-contrast images that accurately capture the color and shape of specimens.

*120% or more than that of previous models.

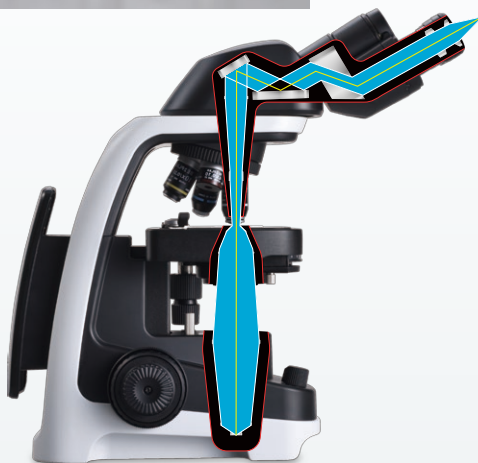
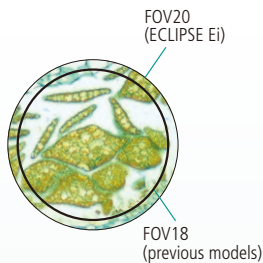

High-magnification objectives with superior image clarity

The bright, high-resolution 100X objective* exhibits superior imaging performance through oil immersion, clearly capturing fine structures. The 60X objective* does not require oil immersion for high magnification observation.

*Optional

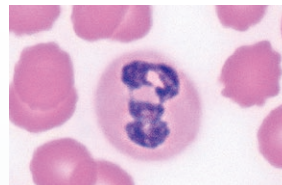

100X oil immersion objective



60X objective

Uniform brightness right up to the periphery of the field of view

The illumination system is equipped with a fly-eye lens to achieve uniform brightness across the entire field of view. Low heat generating, long-life LEDs are utilized as the light source.

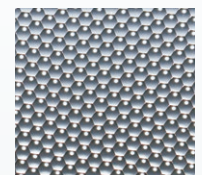

Fly-eye lens

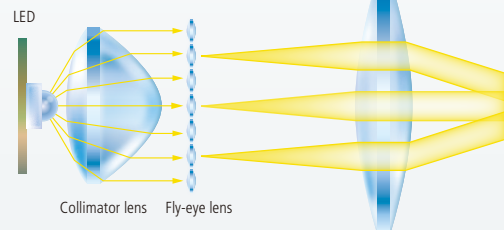

Product lineup

The user can select either a binocular set or a trinocular set. The trinocular set comprises a camera port with a built-in 0.55X zoom lens. Both sets feature two-stage eyepoint height adjustment.



ECLIPSE Ei binocular set



ECLIPSE Ei trinocular set

Digital Sight 1000 microscope camera (optional)

A color camera equipped with a 2-megapixel CMOS image sensor that can acquire images of up to 1920 x 1080 pixels. Simply connecting it to a monitor* and a mouse enables you to capture images without the need for a PC. In addition to still images, it also enables acquisition of movies and simple measurements such as length and angle on a monitor. By connecting the camera to a PC, you can share specimen images being observed with the microscope with other PCs and smart devices. This makes the Digital Sight 1000 perfect not only for recording images, but also for online education and discussions.

* Via a HDMI cable.



Easy image acquisition without a PC

The Digital Sight 1000 can be used with just a monitor and mouse.



Capable of simple measurements

Simple measurements such as measuring the distance between two points can be performed on the monitor.

*Calibration by an optional objective micrometer is required.

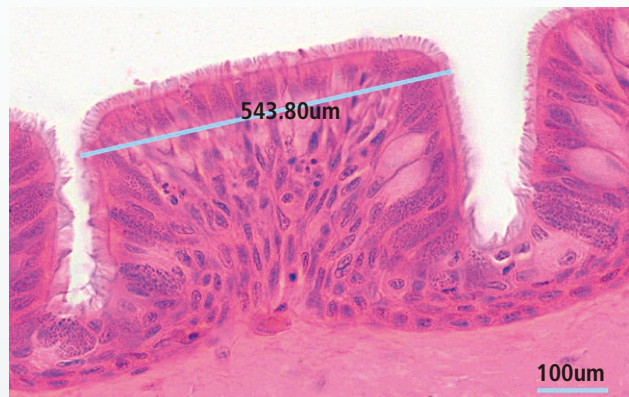

System diagram

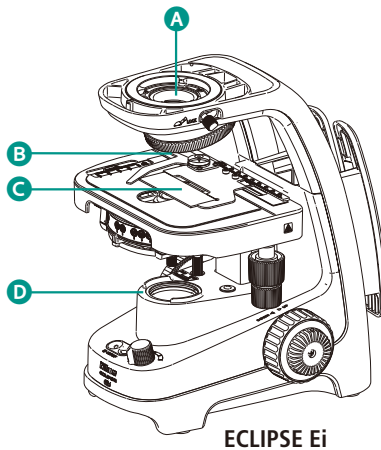
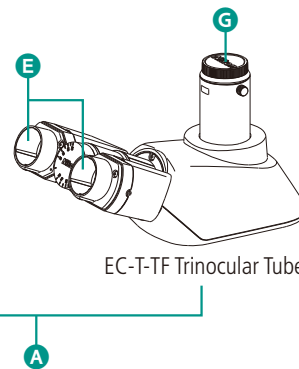
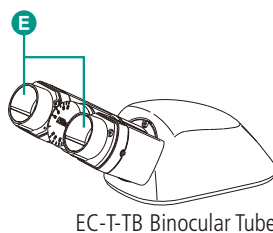

Optional accessories

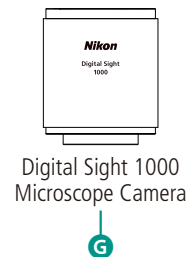
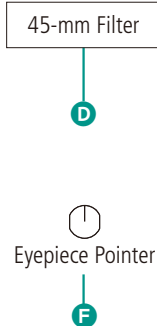
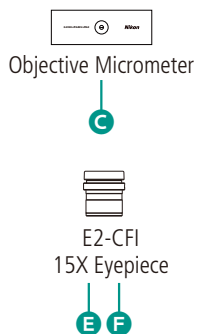
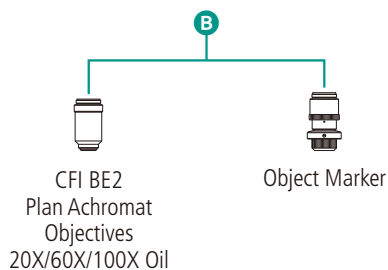

Dimensional diagram

ECLIPSE Ei binocular set

Unit: mm

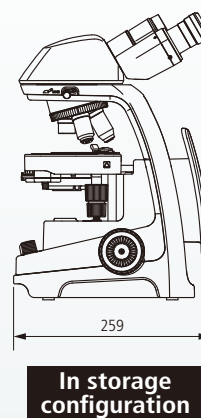
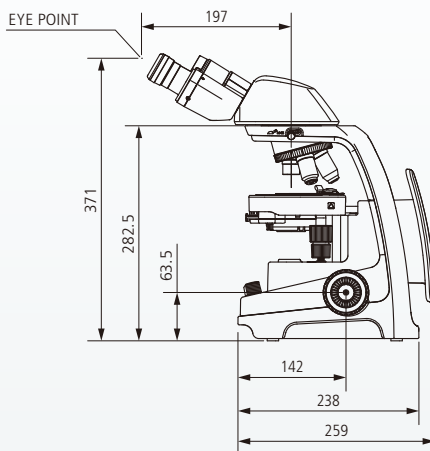
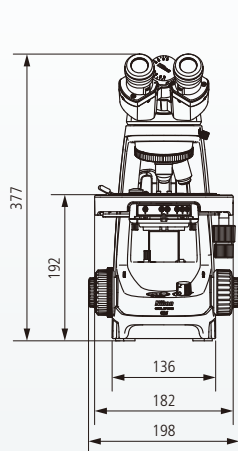

Specifications

| | | |
|--------------------------|-----------------------------------------------------------------------------------------------------------------------------------------------------------------------------------------------------------------------------------------------------------------------------------------------------------------------------------------------------------------------|---------------------------------------------------------------------------------------------------------------------------------------------|
| Main body | ECLIPSE Ei binocular set | ECLIPSE Ei trinocular set |
| Optical system | CFI infinity optical system | |
| Illumination | High luminescent white LED illuminator, 45mm diameter filter can be installed | |
| Eyepieces (F.O.V., mm) | With diopter adjustment <ul style="list-style-type: none"> • EC-E CFI 10X (20) • E2-CFI 15X (12)* | |
| Focusing mechanism | Coaxial coarse/fine focusing, Cross roller guide, Focusing stroke: Up 2 mm/Down 13 mm, Coarse: 37.7 mm/rotation, Fine: 0.2 mm/rotation, With coarse focus knob torque adjustment ring, Includes stage vertical movement stopper | |
| Tubes | EC-T-TB Binocular tube, Inclination: 30°, Pupillary distance: 50 - 75 mm, Eyepoint height: adjustable to 2 positions | EC-T-TF Trinocular tube, Eyepiece/Port: 50/50, Inclination: 25°, Pupillary distance: 50 - 75 mm, Eyepoint height: adjustable to 2 positions |
| Revolving nosepiece | Reversed-type quadruple nosepiece (within main body) | |
| Stage | Rectangular mechanical stage (within main body), with specimen holder, with vernier calibrations, Cross travel: 76 (X) x 30 (Y) mm | |
| Objectives (NA / W.D.) | <ul style="list-style-type: none"> • CFI BE2 Plan Achromat 4X (0.1 / 25mm) • CFI BE2 Plan Achromat 10X (0.25 / 6.7mm) • CFI BE2 Plan Achromat 20X (0.4 / 3.7mm) * • CFI BE2 Plan Achromat 40X (0.65 / 0.6mm) • CFI BE2 Plan Achromat 60X (0.8 / 0.25mm) * • CFI BE2 Plan Achromat 100X Oil (1.25/0.14mm)* | |
| Condenser | Abbe Condenser, NA 0.1~1.25, Color-coded position guide markings of aperture diaphragm, corresponding to objective magnifications | |
| Observation method | Brightfield | |
| Fungus-proof treatment | Antifungal paint is applied around optical system | |
| Optional accessories | Object marker, Eyepiece pointer, 45mm diameter filter, Objective micrometer | |
| Power supply | Uses the included AC adapter (input: 100-240 VAC, 0.48A Max., 50-60 Hz, output: 5.0 VDC, 3.0A Max.) | |
| Power consumption (max.) | Nominal value: 4 W | |
| Weight (approx.) | 5.2 kg | 5.5 kg |

*Optional

Specifications and equipment are subject to change without any notice or obligation on the part of the manufacturer.
September 2020 ©2020 NIKON CORPORATION



Monitor images are simulated.
Company names and product names appearing in this brochure are their registered trademarks or trademarks.
N.B. Export of the products* in this brochure is controlled under the Japanese Foreign Exchange and Foreign Trade Law.
Appropriate export procedure shall be required in case of export from Japan.
*Products: Hardware and its technical information (including software)



Product brochure



Nikon Healthcare Business Unit website



NIKON CORPORATION

Shinagawa Intercity Tower C, 2-15-3, Konan, Minato-ku, Tokyo 108-6290, Japan
phone: +81-3-6433-3705 fax: +81-3-6433-3785
<https://www.healthcare.nikon.com/en/>

ISO 14001 Certified
for NIKON CORPORATION

NIKON INSTRUMENTS INC.

1300 Walt Whitman Road, Melville, N.Y. 11747-3064, U.S.A.
phone: +1-631-547-8500; +1-800-52-NIKON (within the U.S.A. only)
fax: +1-631-547-0299
<https://www.microscope.healthcare.nikon.com/>

NIKON INSTRUMENTS EUROPE B.V.

Tipolis 100, Burgerweeshuispad 101, 1076 ER Amsterdam, Netherlands
phone: +31-20-7099-000 fax: +31-20-7099-298
https://www.microscope.healthcare.nikon.com/en_EU/

NIKON INSTRUMENTS (SHANGHAI) CO., LTD.

CHINA phone: +86-21-6841-2050 fax: +86-21-6841-2060
(Beijing branch) phone: +86-10-5831-2028 fax: +86-10-5831-2026
(Guangzhou branch) phone: +86-2-3882-0551 fax: +86-2-3882-0580
https://www.microscope.healthcare.nikon.com/zh_CN/

NIKON CANADA INC.

CANADA phone: +1-905-625-9910 fax: +1-905-602-9953

NIKON FRANCE S.A.S.

FRANCE phone: +33-1-4516-4516 fax: +33-1-4516-4505

NIKON GMBH

GERMANY phone: +49-211-9414-888 fax: +49-211-9414-322

NIKON INSTRUMENTS S.p.A.

ITALY phone: +39-055-300-9601 fax: +39-055-300-993

NIKON GMBH SWITZERLAND

SWITZERLAND phone: +41-43-277-2867 fax: +41-43-277-2861

NIKON UK LTD.

UNITED KINGDOM phone: +44-208-247-1717 fax: +44-208-541-4584

NIKON CEE GMBH

AUSTRIA phone: +43-1-972-6111 fax: +43-1-972-6111-40

NIKON SINGAPORE PTE LTD

SINGAPORE phone: +65-6559-3651 fax: +65-6559-3668

NIKON INSTRUMENTS KOREA CO., LTD.

KOREA phone: +82-2-2186-8400 fax: +82-2-555-4415

