

ThermTec

WILD PRO

Thermal Imaging Monocular Wild Pro Series User Manual



V1.0

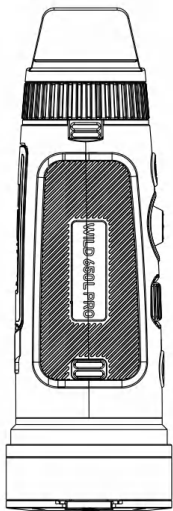
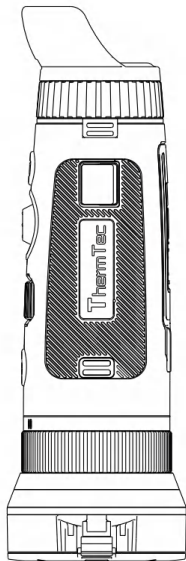

Contents

About This Manual	4	3.3.3.1 Zoom	20
Regulatory Information	5	3.3.3.2 Laser Rangefinder	21
Safety Introduction	7	3.3.3.3 Pseudo Color Switch	21
1. Introduction	11	3.3.4 Capture/Record	23
1.1 Device Description	11	3.4 Set	23
1.2 Features	12	3.4.1 Setting	23
1.3 Application Scenarios	12	3.4.2 System Setting	25
1.4 Appearance	13	3.4.3 Network Connection	31
2. Packing List	16	3.4.3.1 App Download	31
3. Operation Guide	17	3.4.3.2 Connect via Hotspot	31
3.1 Charging	17	3.4.4 File Management	32
3.2 Power On/Off	18	3.5 Data Reading	34
3.3 Buttons and Controls	19	3.6 System Software Upgrade	34
3.3.1 Buttons Combinations and Introduction	19	4. Technical Data	35
3.3.2. Lens Adjustment	20	4.1 Product Size & Drawing	36
3.3.3 Joystick Operation	20	4.2 Specifications	38

About This Manual

COPYRIGHT © 2026 ThermTec Technology Co., Ltd. ALL RIGHTS RESERVED.

Any and all information, including, among others, wordings, pictures, graphs are the properties of ThermTec Technology Co., Ltd. or its subsidiaries (hereinafter referred to as “ThermTec”). This user manual (hereinafter referred to be “the Manual”) cannot be reproduced, changed, translated, or distributed, partially or wholly, by any means, without the prior written permission of ThermTec. Unless otherwise stipulated, ThermTec does not make any warranties, guarantees or representations, express or implied, regarding to the Manual.

This Manual is applicable to Thermal Imaging Monocular.

The Manual includes instructions for using and managing the product. Pictures, charts, images and all other information hereinafter are for description and explanation only. The information contained in the Manual is subject to change, without notice, due to firmware updates or other reasons.

REGULATORY INFORMATION

This product and - if applicable - the supplied accessories too are marked with "CE" and comply therefore with the applicable harmonized European standards listed under the Directive 2014/53/EU(RED), Directive 2014/30/EU(EMC), Directive 2014/35/EU(LVD), Directive 2011/65/EU(RoHS).

The full text of the EU declaration of conformity is available at the following internet address:



<https://www.thermeyertec.com/declaration-of-conformity/>

Frequency Bands and Power (for CE). The frequency bands and transmitting power (radiated and/or conducted) nominal limits applicable to the following radio equipment are as follows: Wi-Fi 2.4 GHz (2.4 GHz to 2.4835 GHz), 17dBm

For the device without a supplied power adapter, use the power adapter provided by a qualified manufacturer. Refer to the product specification for detailed power requirements.

For the device without a supplied battery, use the battery provided by a qualified manufacturer. Refer to the product specification for detailed battery requirements.



This product contains a battery and it is in conformity with the Regulation (EU) 2023/1542. The battery cannot be disposed of as unsorted municipal waste in the European Union. See the product documentation for specific battery information.



The battery is marked with this symbol, which may include lettering to indicate cadmium (Cd), or lead (Pb). For proper recycling, return the battery to your supplier or to a designated collection point. For more information see: www.recyclethis.info.

**UK
CA**

This product and - if applicable - the supplied accessories too are marked with “UKCA” and comply therefore with the following directives: Radio Equipment Regulations 2017, Electromagnetic Compatibility Regulations 2016, Electrical Equipment (Safety) Regulations 2016, the Restriction of the Use of Certain Hazardous Substances in Electrical and Electronic Equipment Regulations 2012.

RoHS

This product and - if applicable - the supplied accessories too are marked with “RoHS” and comply therefore the requirements of Directive 2011/65/EU on the restriction of the use of certain hazardous substances in electrical and electronic equipment (“RoHS recast” or “RoHS 2”).



2012/19/EU (WEEE directive): Products marked with this symbol cannot be disposed of as unsorted municipal waste in the European Union. For proper recycling, return this product to your local supplier upon the purchase of equivalent new equipment, or dispose of it at designated collection points. For more information see: www.recyclethis.info.



Directive 2006/66/EC and its amendment 2013/56/EU (Battery Directive): This product contains a battery that cannot be disposed of as unsorted municipal waste in the European Union. See the product documentation for specific battery information. The battery is marked with this symbol, which may include lettering to indicate cadmium (Cd), lead (Pb), or mercury (Hg). For proper recycling, return the battery to your supplier or to a designated collection point. For more information see: www.recyclethis.info.

SAFETY INTRODUCTION

These instructions are intended to ensure that user can use the product correctly to avoid danger or property loss. Please read all the safety information carefully before using.

Transportation

- Keep the device in original or similar packaging while transporting it.
- Keep all wrappers after unpacking them for future use. In case of any failure occurred, you need to return the device to the factory with the original wrapper. Transportation without the original wrapper may result in damage on the device and the company shall not take any responsibilities.
- Do not drop the product or subject it to physical shock. Keep the device away from magnetic interference.

Power Supply

- If a power adapter is provided in the device package, use the provided adapter only. If no power adapter is provided, ensure the power adapter or other power supply complies with Limited Power Source. Refer to the product label for the power supply output parameters.
- Make sure the plug is properly connected to the power socket.
- DO NOT connect multiple devices to one power adapter, to avoid over heating or fire hazards caused by overload.
- The power delivered by the charger must be between min. 10 Watts required by the radio equipment, and max. 10.4 Watts in order to achieve the maximum charging speed.

Battery

- The device supports removable li-ion battery. The battery rated voltage and capacity is 3.6 V/3300 mAh.
- CAUTION: Risk of explosion if the battery is replaced by an incorrect type. Replace with the same or equivalent type only.

- Batteries of improper size cannot be installed, and may cause abnormal shutdown.
- Improper replacement of the battery with an incorrect type may defeat a safeguard (for example, in the case of some lithium battery types).
- Please purchase the batteries recommended by the manufacturer if necessary.
- The purchased batteries by users need to comply with the relevant international standards about battery safety (e.g. EN/IEC standards).
- Use the battery provided by qualified manufacturer. Refer to the product specification for detailed battery requirements.
- Dispose of used batteries according to the instructions.
- CAUTION: Risks of short circuit, fire, or explosion if the battery is damaged. Frequent use, dropping, impact, corrosion, or compression of the battery may cause damages including cracked casing, detached plates, or leakage of internal liquid or gas, etc.
- If the battery is damaged, stop using it immediately and dispose of it according to the instructions.
- Remove the battery if you do not use the device for a long time.
- For long-term storage of the battery, make sure it is fully charged every 2 months to ensure the battery quality. Otherwise, damage may occur.
- The built-in battery cannot be dismantled. Please contact the manufacture for repair if necessary.
- Make sure the battery temperature is between 0°C to 50°C (32°F to 122°F) when charging.
- Do not dispose of the battery into fire or a hot oven, or mechanically crush or cut the battery, which may result in an explosion.
- Do not leave the battery in an extremely high temperature or low air pressure environment, which may result in an explosion or the leakage of flammable liquid or gas.
- Confirm there is no flammable material within 2 m of the charger during charging.
- DO NOT place the device with battery or the battery alone near heating or fire source. Avoid direct sunlight.
- DO NOT place the battery in the reach of children.
- DO NOT swallow the battery to avoid chemical burns.

- This product contains a coin/button cell battery. If the coin/button cell battery is swallowed, it can cause severe internal burns in just 2 hours and can lead to death.
- If the battery compartment does not close securely, stop using the product and keep it away from children.
- If you think batteries might have been swallowed or placed inside any part of the body, seek immediate medical attention.

Maintenance

- If the product does not work properly, please contact your dealer or the nearest service center. We shall not assume any responsibility for problems caused by unauthorized repair or maintenance.
- Make sure that the power has been disconnected before device teardown and repair by professionals.
- Check the optical surfaces of objective lens, eyepiece, rangefinder, etc. If necessary, remove dust and sand from the optics using tools and solvent designed especially for this purpose (it is preferable to use a non-contact method).
- If the equipment is used in a manner not specified by the manufacturer, the protection provided by the device may be impaired.
- Wipe the exterior surfaces of metal, plastic, and silicone parts with a clean and soft cloth. Do not use chemically active substances, solvents, etc. as these may damage the paint.

Using Environment

- Make sure the running environment meets the requirement of the device. The operating temperature shall be -20 °C to 50 °C , and the operating humidity shall be from 5% to 95%.
- DO NOT expose the device to high electromagnetic radiation or dusty environments.
- DO NOT aim the lens at the sun or any other bright light.
- Place the device in a dry and well-ventilated environment.
- When any laser equipment is in use, make sure that the device lens is not exposed to the laser beam, or it may burn out.

- Avoid equipment installation on vibratory surface or places subject to shock (neglect may cause equipment damage).
- This equipment is not suitable for use in locations where children are likely to be present.

Emergency

- If smoke, odor, or noise arises from the device, immediately turn off the power, unplug the power cable, and contact the service center.

Laser



When any laser equipment is in use, make sure that the device lens is not exposed to the laser beam, or it may burn out. The laser radiation emitted from the device can cause eye injuries, burning of skin or inflammable substances. Before enabling the laser ranging function, make sure no human or inflammable substances are in front of the laser lens. Do not place the device where minors can fetch it. According to IEC 60825-1:2014, EN 60825-1:2014+A11:2021, and EN 50689:2021, this laser product is classified as Class 1 laser product and consumer laser product.

1 Introduction

1.1 Device Description

Wild Pro Thermal Imaging Monocular series is designed with a NETD < 15mK, 12 μ m uncooled infrared detector and 1600 \times 1200 OLED high-definition display. With AI image recognition algorithm, it gets clear views under various lighting conditions, even in complete darkness, providing reliable and high-quality visual images for night activities. It can also view the moving target and meet the outdoor conditions. The apparatus can be widely used for searching and rescuing, hunting, etc.



1.2 Features

- 12 μ m uncooled infrared detector, NETD < 15mK;
- 1x–4x continuous digital zoom;
- Inbuilt LRF ranging in the lens up to 1000m;
- Various pseudo colors;
- Joystick control design, wheel focusing realizes one-hand operation;
- Detector anti-burn mechanism;
- Super large aperture offers better temperature radiation capturing capability;
- 1600*1200 resolution with 0.5 inch OLED display;
- Up to 6h continuous working for lithium battery;
- Optional dual-FOV lens design

1.3 Application Scenarios

- Animal Observation
- Outdoor Adventure
- Security Law Enforcement
- Emergency Search and Rescue

1.4 Appearance



Wild 650DL Pro

NO.	Comments
1	Lens Cover
2	Power Button
3	Focusing Knob
4	Joystick
5	Capture/Record Button
6	Diopter Knob
7	Eyecup
8	Compartment of Replaceable Battery
9	Type-C Port
10	Laser Module
11	Dual FOV Switch



Wild635L Pro

NO.	Comments
1	Lens Cover
2	Power Button
3	Focusing Knob
4	Joystick
5	Capture/Record Button
6	Diopter Knob
7	Eyepiece Cover
8	Compartment of Replaceable Battery
9	Type-C Port
10	Laser Module



Wild650L Pro

NO.	Comments
1	Lens Cover
2	Power Button
3	Focusing Knob
4	Joystick
5	Capture/Record Button
6	Diopter Knob
7	Eyepiece Cover
8	Compartment of Replaceable Battery
9	Type-C Port
10	Laser Module

2 Packing List



Monocular (x1)

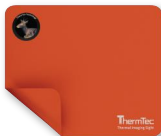

Lens cloth (x1)



User manual (x1)



Service and support card (x1)



Bag (x1)



Lanyard (x1)



Hand strap (x1)



Charger (x1)



Lithium battery (x2)



USB cable (x1)

3 Operation Guide

3.1 Charging

Here are two methods we could take to charge the device. Device Charging and Battery Charging.

Device Charging:

Connect the device and power adaptor directly with a type-C cable to power on the device. Alternatively, connect the device and PC to export files. Follow the below steps to charge the battery:

- Lift the cover from the USB port.
- Plug the cable provided into the USB port.
- Plug the opposite end of the cable into a USB power source.



Battery Charging:

Wild Pro have adopted replaceable and rechargeable battery design. The batteries could be taken off and charged directly, from which dramatically improves the device life.



3.2 Power On/Off

Press and hold the power button to power on/power off the device.

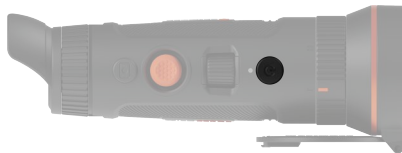



Note:

- The battery should be fully charged prior to use.
- The battery is supposed to be taken out for long time non-using occasions.

3.3 Buttons and Controls

3.3.1 Buttons Combinations and Introduction

Before entering the main menu			
Icon	Short Press	Long Press	Double Press
	Standby mode	On/Off	N/A
	Capture	Record	N/A

Icon	Up	Down	Left	Right		Center	
	Zoom in	Zoom out	LRF range finder	Short push	Long push	Brief click	Double click
				Pseudo switch	Outline	Calibration	Menu

After entering the main menu					
Icon	Up	Down	Left	Right	Short Press
	Move up	Move down	Exit Sub-menu	Open Sub-menu	Confirm

3.3.2 Lens Adjustment

Diopter Adjustment

Looking through the eyepiece, adjust the position of diopter level to optimize the image sharpness on the OLED display.



Objective Lens Focusing

Manually adjust the objective lens focus when you can't see the scene clearly.

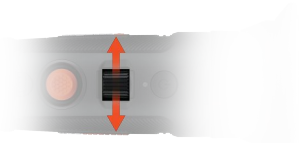

FOV Selection and Switch

To adjust focal length from 25mm to 50mm.



Notice: There should be switched at the limiting position during the two diverse lenses changed. This function is just in the Wild 650DL Pro.

3.3.3 Joystick Operation

3.3.3.1 Zoom

Push the joystick to the front to zoom in, vice versa.



3.3.3.2 Laser Rangefinder

Push the joystick to the left to activate laser rangefinder.



3.3.3.3 Pseudo Color Switch

Brief push joystick to the right to switch pseudo colors.



There are totally six pseudo colors
(white hot, black hot, red hot, green, golden, violet) for user choice.



White



Black



Red



Green



Golden



Violet

3.3.4 Capture/Record Image Capturing

Press Capture button to take photos. Then the photo icon in the upper left corner will flash once.



Video Recording

Press and hold Capture button to take videos. Then the recording icon starts flashing in the upper left corner, and the recording starts timing. Press and hold again to stop recording.



3.4 Set

Select setting and double-click the joystick to enter setting menu.

Note: Select by moving the joystick, and short press the joystick to confirm the selection.

3.4.1 Setting



Press to enter the Imaging Setting menu. There are five sub-menus for image setting, which are "Image Mode", "Sharpness", "Denoise", "Brightness" and "Contrast".

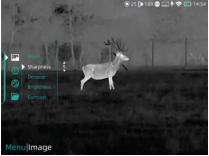

Image Settings





Mode	Forest	<p>Forest: The image details would be enhanced in a way. Target: Outstanding target shape, more suitable for heavy weather.</p> 
Sharpness	0-10	<p>Adjust image sharpness to make the image edge sharper. The recommended value is 5.</p> 
Denoise	0-10	<p>Adjust image noise to make the image cleaner. The recommended value is 5.</p>
Brightness	1-10	<p>Adjust image brightness to make the image brighter. The recommended value is 5.</p>
Contrast	1-10	<p>Adjust image contrast to make the target more prominent in the image. The recommended value is 5.</p>



3.4.2 System Setting





Press joystick to confirm setting to enter the System Setting menu. Select by moving the joystick, and short-press the joystick to confirm the selection.

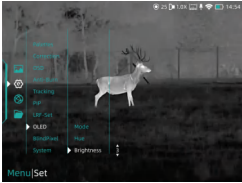

System Setting		
Palettes	Target color	Totally six palettes could be set up. 
Correc-tion	/	The image correction mode could be set by Auto or Manual. 

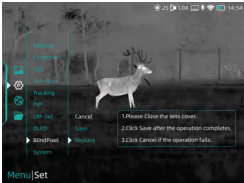

OSD	On-screen display	Enable this feature to decide if the menu icons display in the recorded videos. 
Anti-Burn	/	Detector anti-burn function, it could be set by on/off. 

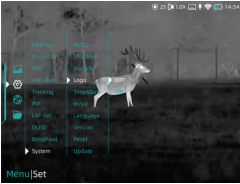

<p>Anti-Burn</p>	<p>/</p>	<p>Once it detects harmful rays to the detector, the system will enable protection automatically.</p> 
<p>Tracking</p>	<p>/</p>	<p>Turn on heat tracking to mark the target with the highest temperature in real time in the screen.</p> 
<p>PIP</p>	<p>Picture in picture</p>	<p>In the picture, the image is 2x enlarged from the center of the cross.</p> 
<p>Ranging</p>	<p>LRF-Set</p>	<p>It includes the default information of LRF location. Warning: No modification is allowed in this section.</p> 

<p>Ranging</p>	<p>LRF-Set</p>	
<p>OLED</p>	<p>Mode</p>	<p>User can set up the needed model.</p> 
<p>OLED</p>	<p>Hue</p>	<p>Gray, Blue, Purple and Red are optional for OLED hue.</p> 
<p>OLED</p>	<p>Brightness</p>	<p>The brightness could be adjusted here to make the image brighter or darker. The value could be set by 1-5.</p> 

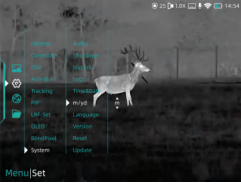
<p>Blind Pixel</p>	<p>/</p>	<p>The blind pixel in the picture can be replaced. We could replace bind pixels, save the current settings or cancel it.</p> 	<p>System Shutdown</p>	<p>The device could be set to shutdown after 30mins, 60mins, or you could turn off the function.</p> 
<p>System Audio</p>	<p>Audio</p>	<p>Turn on or off audio function.</p> 	<p>System Joystick</p>	<p>Customize the sensitivity range of joystick towards each direction, so it could be better adjusted to every individual needs and requirements.</p> 

System	Logo	<p>The logo on the screen could be turned on or turned off.</p> 
System	<p>Time</p> <hr/> <p>Date</p>	<p>Time and Date could be set here.</p> 

System	M/yd	<p>The measuring distance unit could be set by meter or yard.</p> 
System	Lang	<p>System language could be set here.</p> 

<p>System</p>	<p>Version</p>	<p>We could check the information of current version here.</p> 
<p>System</p>	<p>Reset</p>	<p>The settings of images could be reset here.</p> 

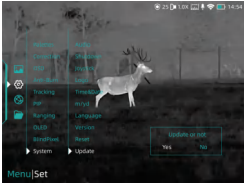
<p>System</p>	<p>Update</p>	<p>You can adjust and upgrade the device system.</p> 
----------------------	----------------------	---

3.4.3 Network Connection

Select Internet icon to and press joystick to enter the Network Connection menu.



3.4.3.1 App Download

You may download the "ThermTec Outdoor" APP through the QR code shown on the packing box, user manual or below.



3.4.3.2 Connect via Hotspot

Turn on device's hotspot.

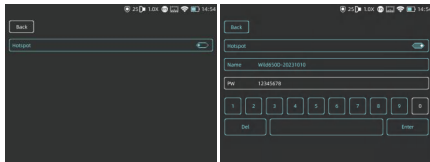

- Connect mobile client with device's hotspot.
- After the connection, you could control devices freely with APP (ThermTec Outdoor).

3.4.4 File Management

Select Files and press the joystick to enter the Files. Select the image and video sub-menus to view the images and videos and play the videos.

Image Viewing

- Press the joystick to enter image files.

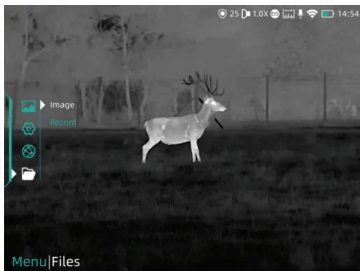

- After selecting a certain image, press joystick to access further operations of the image, we could delete it, check next one or delete all the images.

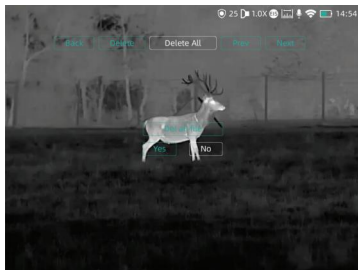
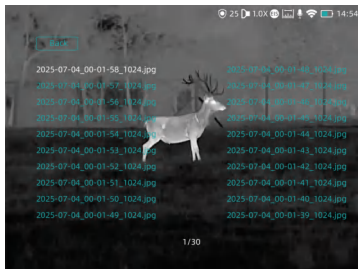

Video Viewing

- Select Record and press joystick to enter video files.



- Further operations could be accessed here, we could delete it, check next one, pause the video or delete all the videos.

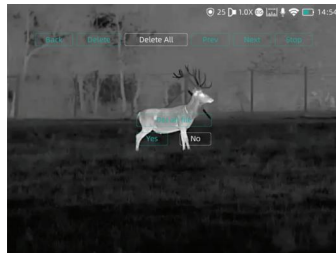

- Choose a certain video and press joystick to check the video.

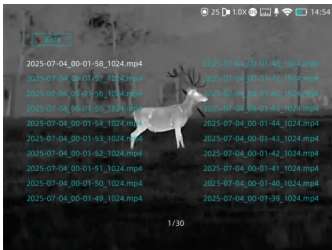

3.5 Data Reading

Data Reading

When external display is connected, the OLED of the device automatically turns off. Power on the device, use a type-C USB cable to connect with the computer to read the video and image data in the memory.

Note: Videos, images and rav videos taken will be saved separately in folders named “record”, “image” and “rav”.

3.6 System Software Upgrade

Wild Pro series supports “ThermTec Outdoor” APP, which allows you to transmit the image from the thermal imager to the smartphone or tablet via Hotspot in real time mode.

Upgrading via APP

- Open ThermTec Outdoor APP.
- Turn on the hotspot of the device, and connect it with the Mobile phone.
- Select Update on the menu options.
- The downloading and upgradation would be a continuous process if there is an update.
- After finishing the update, the device will reboot.

Upgrading via PC

- Copy the related updating firmware to the storage file of Wild Pro.



- Copy the related updating firmware to the file folder of Wild Pro. Press joystick to select Update icon, and the system will prompt “Update”.

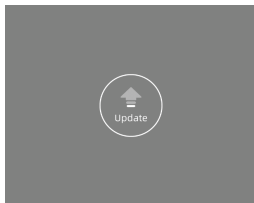

- Enter Version menu to check firmware version.

4 Technical Data

4.1 Product Size & Drawing

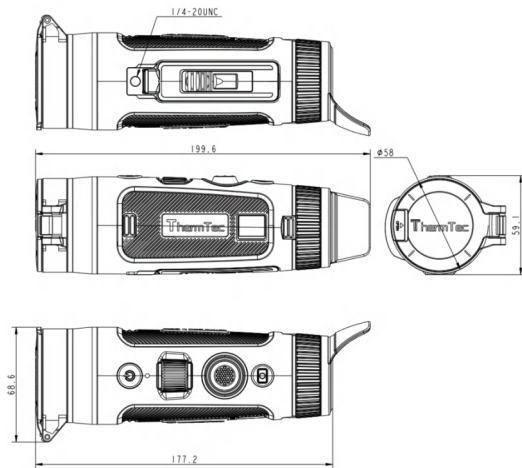

Wild635L Pro size

4 Technical Data

4.1 Product Size & Drawing

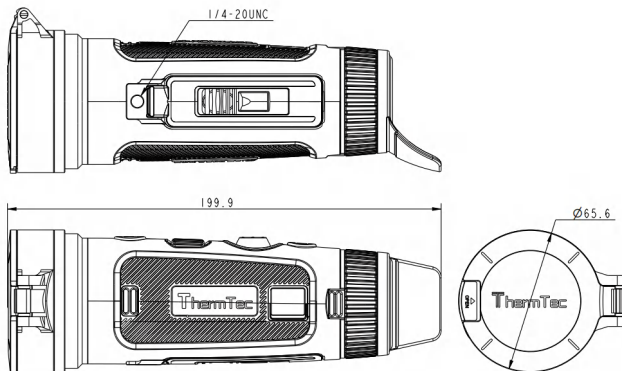

Wild650L Pro size

4 Technical Data

4.1 Product Size & Drawing

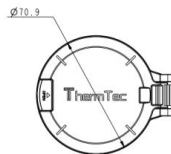
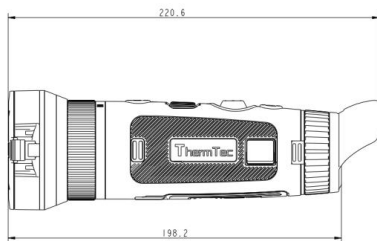
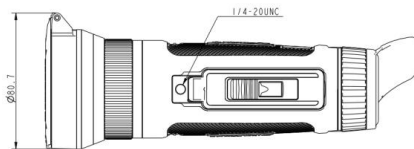

Wild 650DL Pro size

4.2 Specifications

Model	Wild635L Pro	Wild650L Pro	Wild 650DL Pro
Microbolometer			
Resolution	640×512		
Pixel pitch	12μm		
NETD	< 15mK@300K		
Spectral range	8-14μm		
Frame rate	50Hz		
Detection range	1800m	2600m	1300m/2600m
Optics			
Objective lens	35mm	50mm	25mm/50mm
F number	F0.8	F0.9	F0.9/F0.9
m@100m	21.9×17.6	15.4×12.3	30.7×24.6/ 15.4×12.3
Field of view	12.5°×10.0°	8.8° × 7.0°	17.5° × 14°/ 8.8° × 7.0°
Magnification	2.5X	3.6X	1.8X-3.6X
Digital zoom	1-4X continuous zoom		
Eye relief	20mm		
Exit pupil	8mm		
Diopter	±5D		
Display			
Type	AMOLED		
Resolution	1600×1200		
Display size	0.5 inch		
Color palette	6		
Image mode	Forest/Target		

Function			
Photo / Video playback	Yes		
Language	Multiple-language		
Inbuilt memory	64GB		
PIP	Yes		
Hot track	Yes		
OSD recording	Yes		
Burn prevention	Yes		
Battery			
Internal battery	Replaceable and rechargeable Li-ion battery (18650x1)		
Battery life	6h		
Interface			
Type C	Battery charge, Data transfer, USB video output		
Hotspot	Yes, App remote control		
Environment			
Working temperature	-20°C to +50°C		
Protection level	IP67		
Weight, g	510±5	537±5	653±5
Dimension,mm	200(L)×69(W) ×60(H)±5	200(L)×76(W) ×66(H)±5	221(L)×71(W) ×81(H)±5
Accessories			
External cable	Type-C-USB cable		
Other accessories	Palm strap/Protective bag/ Non-dust cloth and etc.		
Laser Rnagefinder			
Safety class	Class 1		
Wavelength	905nm		
Range	1000m		
Accuracy	±1m		



ThermTec Technology Co., Ltd.

✉ info@thermeyetec.com

🌐 www.thermeyetec.com



COPYRIGHT © 2026 ThermTec Technology Co., Ltd. ALL RIGHTS RESERVED.